

3216

PID TEMPERATURE
CONTROLLER



User Guide



invensys

EUROTHERM

3216 PID Temperature Controller

Contents

| | | |
|-----------|---|----------|
| 1. | What Instrument Do I Have? | 4 |
| 1.1 | Unpacking Your Controller | 4 |
| 1.2 | Dimensions..... | 5 |
| 1.3 | Step 1: Installation..... | 6 |
| 1.3.1 | Panel Mounting the Controller | 6 |
| 1.3.2 | To Remove the Controller from its Sleeve..... | 6 |
| 2. | Order Code | 7 |
| 3. | Step 2: Wiring | 8 |
| 3.1 | Terminal Layout..... | 8 |
| 3.2 | Wire Sizes | 9 |
| 3.3 | PV Input (Measuring Input) | 9 |
| 3.3.1 | Thermocouple Input..... | 9 |
| 3.3.2 | RTD Input..... | 9 |
| 3.3.3 | Linear Input (mA or V) | 9 |
| 3.4 | AA Output Relay (Optional)..... | 9 |
| 3.5 | Input/Output 1 (Relay or Logic or DC - Optional)..... | 10 |
| 3.6 | Output 2 (Relay or Logic or DC - optional) | 10 |
| 3.7 | Digital Communications (Optional) | 11 |
| 3.8 | Current Transformer/Logic Input (Optional)..... | 12 |
| 3.8.1 | Current Transformer Input (CT)..... | 12 |

| | | |
|-------------|--|-----------|
| 3.8.2 | Logic Input (LA) | 12 |
| 3.9 | Power Supply | 12 |
| 3.10 | Example Wiring Diagram | 13 |
| 4. | Installation Safety Requirements | 14 |
| 5. | Switch On | 16 |
| 5.1 | Initial Configuration | 16 |
| 5.2 | To Re-Enter Quick Code mode..... | 18 |
| 5.3 | Pre-Configured Controller or Subsequent Starts | 19 |
| 5.4 | Operator Interface | 20 |
| 5.4.1 | To Set The Required Temperature. | 21 |
| 5.4.2 | Alarm Indication | 21 |
| 5.4.3 | Auto/Manual/Off Mode | 22 |
| 5.4.4 | To Select Manual Operation and Adjust the Output Power | 23 |
| 5.4.5 | Other Commonly Used Operator Parameters Available in Level 1 | 24 |
| 6. | Operator Level 2 | 25 |
| 6.1 | To Enter Level 2 | 25 |
| 6.2 | To Return to Level 1 | 25 |
| 6.3 | Level 2 Parameters | 26 |
| 6.4 | Timer | 33 |
| 6.4.1 | Timer Beacon | 34 |
| 6.4.2 | Logic outputs..... | 34 |
| 6.4.3 | Power Cycling..... | 34 |
| 6.5 | Dwell Timer | 35 |
| 6.6 | Delayed Switch On Timer | 36 |

| | | |
|------------|-----------------------------------|-----------|
| 6.7 | Soft Start Timer | 37 |
| 6.8 | To Operate the Timer | 38 |
| 6.9 | Programmer | 39 |
| 6.9.1 | Power Cycling (Programmer) | 40 |
| 6.9.2 | Threshold | 40 |
| 6.9.3 | To Operate the Programmer | 41 |
| 6.9.4 | To Configure the Programmer | 42 |

Issue 2 of this User Guide applies to controller software version 2.01 and greater

Installation and Basic Operation

1. What Instrument Do I Have?

Thank you for choosing the 3216 Temperature Controller/Programmer.

This User Guide takes you through step by step instructions to help you to install, wire, configure and use the controller. For features not covered in this User Guide, a detailed Engineering Manual, Part No HA027986, and other related handbooks can be downloaded from www.eurotherm.co.uk

The controller may have been ordered to a hardware code only or pre-configured using an optional 'Quick Start' code. The label fitted to the side of the sleeve shows the ordering code that the controller was supplied to where the last two sets of five digits show the Quick Code. If the Quick Code shows XXXXX/XXXXX the controller will need to be configured when it is first switched on.

1.1 Unpacking Your Controller

The following items are included in the box:-

- Controller mounted in its sleeve
- Two panel retaining clips mounted on the sleeve
- IP65 sealing gasket mounted on the sleeve
- Component packet containing a snubber for each relay output (see section 3.5) and a 2.49 Ω resistor for current inputs (see section 3)
- This User Guide

1.2 Dimensions

A general view of the controller is shown below together with overall dimensions.

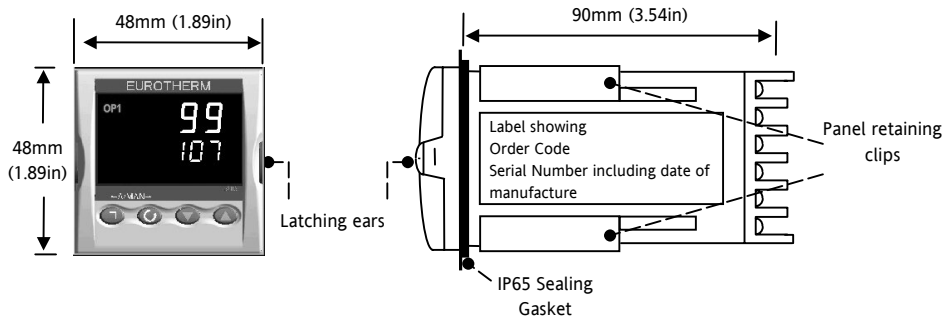

1.3 Step 1: Installation

This instrument is intended for permanent installation, for indoor use only, and enclosed in an electrical panel. Select a location which is subject to minimum vibrations and the ambient temperature is within 0 and 55°C (32 - 131°F).

The instrument can be mounted on a panel up to 15mm thick.

To ensure IP65 and NEMA 4 front protection, mount on a non-textured surface.

Please read the safety information in section 4 before proceeding and refer to the EMC Booklet part number HA025464 for further installation information.

1.3.1 Panel Mounting the Controller

1. Prepare a square cut-out in the mounting panel to the size shown. If a number of controllers are to be mounted in the same panel they should be spaced as shown.
2. Fit the IP65 sealing gasket, if required, behind the front bezel of the controller.
3. Insert the controller through the cut-out.
4. Spring the panel retaining clips into place. Secure the controller in position by holding it level and pushing both retaining clips forward.
5. Peel off the protective cover from the display.

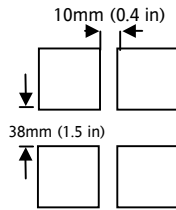
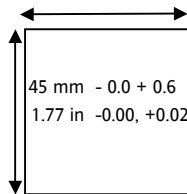

(Not to scale)

Recommended minimum spacing of controllers

1.3.2 To Remove the Controller from its Sleeve

The controller can be unplugged from its sleeve by easing the latching ears outwards and pulling it forward out of the sleeve. When plugging it back into its sleeve, ensure that the latching ears click back into place to maintain the IP65 sealing.

2. Order Code

| Model | | Power supply | Input/output 1 & output 2 | X | Output AA | Comms, CT & Dig input | Fascia colour | Product Language | Manual Language | Quick start code |
|-------|----|--------------|---------------------------|---|-----------|-----------------------|---------------|------------------|-----------------|------------------|
| 3216 | CC | | | | | | | | | Optional |

| Model | |
|-------|--------------------------|
| CC | Controller |
| CP | Programmer 1 X 8 segment |

| Output AA | |
|-----------|----------------|
| R | Relay (Form C) |
| X | Not fitted |

| Fascia colour | |
|---------------|--------|
| G | Green |
| S | Silver |

| Power Supply | |
|--------------|-----------|
| VL | 20 – 29V |
| VH | 110 –240V |

| Communications, CT & Digital Input | | | |
|------------------------------------|---|---|-----------------------|
| X | X | X | Not fitted |
| 4 | X | L | RS485 2-wire & Dig in |
| 2 | X | L | RS232 2-wire & Dig in |
| 4 | C | L | RS485, CT & Dig in |
| 2 | C | L | RS232, CT & Dig in |
| X | X | L | Digital input only |
| X | C | L | CT & Digital input |

| Product Language Manual Language | |
|-------------------------------------|---------|
| ENG | English |
| FRA | French |
| GER | German |
| ITA | Italian |
| SPA | Spanish |

| Input/output 1 & Output 2 | | |
|---------------------------|-----|----------------------|
| OP1 | OP2 | |
| L | X | Logic I/O |
| L | L | Logic I/O + logic OP |
| L | R | Logic I/O + relay |
| R | R | Relay + relay |
| D | D | DC OP+ DC OP |
| L | D | Logic I/O + DC OP |
| D | R | DC OP + Relay |
| X | X | Not fitted |

| Quick Start Code |
|-----------------------|
| See Switch On section |

3. Step 2: Wiring

3.1 Terminal Layout

Warning

Ensure that you have the correct supply for your controller

Check order code of the controller supplied

Input/Output 1

Input - Digital
Output - Relay or
Logic or
DC

Output 2

Relay or Logic or
DC

Line Supply

85 to 264Vac
50/60Hz

OR

Low Voltage Supply

24Vac/dc

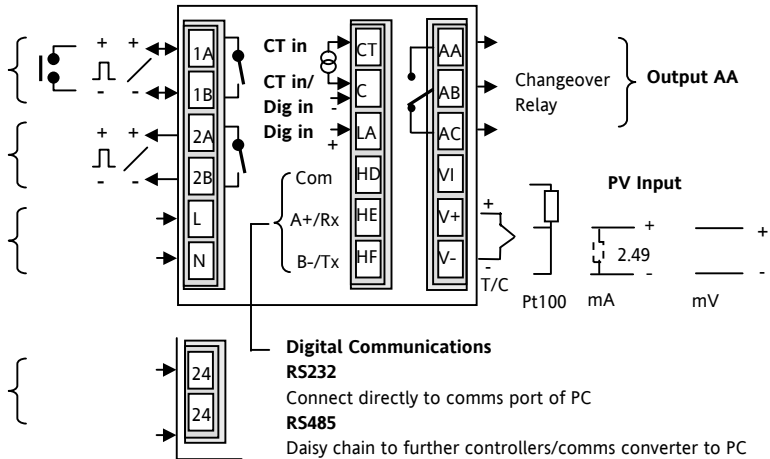

3.2 Wire Sizes

The screw terminals accept wire sizes from 0.5 to 1.5 mm (16 to 22AWG). Hinged covers prevent hands or metal making accidental contact with live wires. The rear terminal screws should be tightened to 0.4Nm (3.5lb in).

3.3 PV Input (Measuring Input)

- Do not run input wires together with power cables
- When shielded cable is used, it should be grounded at one point only
- Any external components (such as zener barriers, etc) connected between sensor and input terminals may cause errors in measurement due to excessive and/or un-balanced line resistance or possible leakage currents

3.3.1 Thermocouple Input

- For thermocouple input use the correct compensating cable preferably shielded

3.3.2 RTD Input

- The resistance of the three wires must be the same. The line resistance may cause errors if it is greater than 22Ω

3.3.3 Linear Input (mA or V)

- A line resistance for voltage inputs may cause measurement errors
- Volts input (input resistance $100K\Omega$). An external adaptor is required, Part No. SUB21/11
- For mA input connect the 2.49Ω burden resistor, supplied, across the + and - input

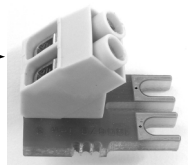

3.4 AA Output Relay (Optional)

- Changeover relay (Form C) rated 2A 264Vac resistive

3.5 Input/Output 1 (Relay or Logic or DC - Optional)

- This is optional and may be logic input, logic output, relay output or 0-20mA dc output:-

| | | |
|--------|-----------------|--|
| Output | Relay | Normally open (Form A), 2A 264Vac resistive |
| | Logic | Drive to SSR (not isolated) Logic level On/High - 12Vdc at 5 to 40mA max Logic level Off/Low - <100mV <100µA |
| | DC | 0-20mA, load 500Ω max, cal accuracy 1% \pm 100µA offset |
| Input | Logic (Digital) | Contact closure 12V @ 5-40mA Contact open > 500Ω Contact closed < 200Ω |

3.6 Output 2 (Relay or Logic or DC - Optional)

This is optional and is output only. It may be relay, logic or 0-20mA dc output as Output 1.

* General Note About Relays and Inductive Loads

High voltage transients may occur when switching inductive loads such as some contactors or solenoid valves. Through the internal contacts, these transients may introduce disturbances which could affect the performance of the instrument. For this type of load it is recommended that a 'snubber' is connected across the normally open contact of the relay switching the load. The snubber recommended consists of a series connected resistor/capacitor (typically 15nF/100Ω). A snubber will also prolong the life of the relay contacts.

WARNING

When the relay contact is open or it is connected to a high impedance load, the snubber passes a current (typically 0.6mA at 110Vac and 1.2mA at 240Vac). You must ensure that this current will not hold on low power electrical loads. If the load is of this type the snubber should not be connected.

3.7 Digital Communications (Optional)

Digital communications uses the Modbus protocol. The interface may be ordered as RS232 or RS485 (2-wire).

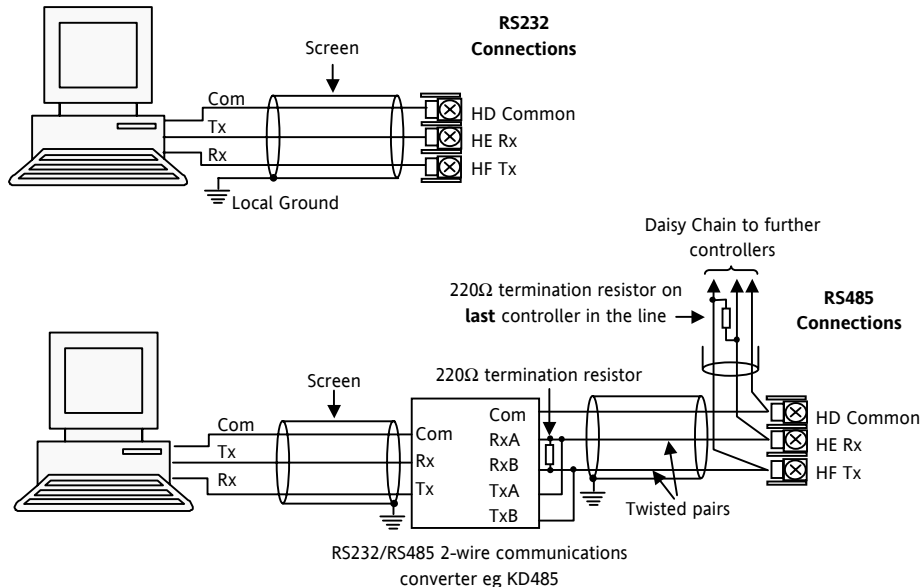

3.8 Current Transformer/Logic Input (Optional)

A current transformer can be connected directly to the controller to monitor the actual rms current supplied to an electrical load.

3.8.1 Current Transformer Input (CT)

CT input current 0 to 50mA rms (sine wave, calibrated) 50/60Hz. A burden resistor, value 10Ω , is fitted inside the controller. It is recommended that the current transformer is fitted with a voltage limiting device, such as two back to back zener diodes between 3 and 10V and rated for 50mA.

CT input resolution 0.1A for scale up to 10A, 1A for scale 11 to 100A

CT input accuracy $\pm 4\%$ of reading

3.8.2 Logic Input (LA)

A digital (logic) input from a volt free contact can be configured to select Setpoint 2, Keylock, Timer Run/Hold, Timer Reset, Alarm Acknowledge or Auto/Manual.

| | | |
|---------------|------------------------------|-------------------------------|
| Digital Input | Contact closure 12V @ 5-40mA | |
| | Contact open > 500 Ω | Contact closed < 200 Ω |

Note: This supplies 12Vdc at up to 10mA to terminal LA

The common connection is shared for each of these inputs and is, therefore, not isolated.

3.9 Power Supply

1. Before connecting the instrument to the power line, make sure that the line voltage corresponds to the description on the identification label. Use copper conductors only.
2. For 24V the polarity is not important

The power supply input is not fuse protected. This should be provided externally: Instrument fuse ratings are as follows:-

- For 24 V ac/dc fuse type T rated 2A 250V
- For 85/265Vac fuse type T rated 2A 250V

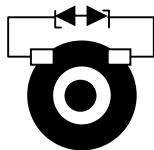

3.10 Example Wiring Diagram

This example shows heat/cool temperature controller where the heater control uses a SSR and the cooling control uses a relay.

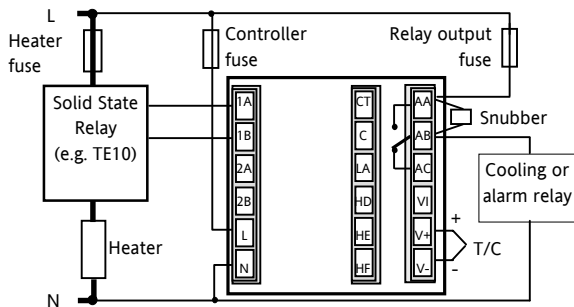

Safety requirements for permanently connected equipment state:

- A switch or circuit breaker shall be included in the building installation
- It shall be in close proximity to the equipment and within easy reach of the operator
- It shall be marked as the disconnecting device for the equipment

Note: a single switch or circuit breaker can drive more than one instrument

4. Installation Safety Requirements

Safety Symbols

Various symbols may be used on the controller. They have the following meaning:



Caution, (refer to accompanying documents)



Equipment protected throughout by DOUBLE INSULATION

Personnel

Installation must only be carried out by suitably qualified personnel

Enclosure of Live Parts

To prevent hands or metal tools touching parts that may be electrically live, the controller must be enclosed in an enclosure.

Caution: Live sensors

The controller is designed to operate with the temperature sensor connected directly to an electrical heating element. However you must ensure that service personnel do not touch connections to these inputs while they are live. With a live sensor, all cables, connectors and switches for connecting the sensor must be mains rated.

Wiring

It is important to connect the controller in accordance with the wiring data given in this guide. Take particular care not to connect AC supplies to the low voltage sensor input or other low level inputs and outputs. Only use copper conductors for connections (except thermocouple inputs) and ensure that the wiring of installations comply with all local wiring regulations. For example in the UK use the latest version of the IEE wiring regulations, (BS7671). In the USA use NEC Class 1 wiring methods.

Power Isolation

The installation must include a power isolating switch or circuit breaker. This device should be in close proximity to the controller, within easy reach of the operator and marked as the disconnecting device for the instrument.

Overcurrent protection

The power supply to the system should be fused appropriately to protect the cabling to the units.

Voltage rating

The maximum continuous voltage applied between any of the following terminals must not exceed 264Vac:

- relay output to logic, dc or sensor connections;
- any connection to ground.

The controller must not be wired to a three phase supply with an unearthed star connection. Under fault conditions such a supply could rise above 264Vac with respect to ground and the product would not be safe.

Conductive pollution

Electrically conductive pollution must be excluded from the cabinet in which the controller is mounted. For example, carbon dust is a form of electrically conductive pollution. To secure a suitable atmosphere in conditions of conductive pollution, fit an air filter to the air intake of the cabinet. Where condensation is likely, for example at low temperatures, include a thermostatically controlled heater in the cabinet.

Over-temperature protection

Where damage or injury is possible, we recommend fitting a separate over-temperature protection unit, with an independent temperature sensor, which will isolate the heating circuit.

Please note that the alarm relays within the controller will not give protection under all failure conditions.

Installation requirements for EMC

To ensure compliance with the European EMC directive certain installation precautions are necessary as follows:

For general guidance refer to Eurotherm Controls EMC Installation Guide, HA025464.

When using relay outputs it may be necessary to fit a filter suitable for suppressing the emissions. The filter requirements will depend on the type of load. For typical applications we recommend Schaffner FN321 or FN612.

5. Switch On

A brief start up sequence consists of a self test in which all elements of the display are illuminated and the software version number is shown. What happens next depends on one of two conditions:-





1. The instrument is new and has been supplied un-configured (go to section 5.1)
2. The instrument has been supplied configured in accordance with the Quick Start code (go to section 5.3)





5.1 Initial Configuration

If the controller has not previously been configured it will start up showing the 'Quick Configuration' codes. This is a built in tool which enables you to configure the input type and range, the output functions and the display format.

The quick code consists of two 'SETS' of five characters. The upper section of the display shows the set selected, the lower section shows the five digits which make up the set. Adjust these as follows:-



1. Press any button. The * characters will change to '-' the first one flashing. * indicates the option is not fitted
2. Press  or  to change the character currently flashing to the required code shown in the quick code tables.
3. Press  to scroll to the next character. If you need to return to the first character press . When all five characters have been configured the display will go to Set 2.

When the last digit has been entered press  again, the display will show  Press  or  to YES. The controller will automatically go to the operator level.



| To configure PV Input type | To configure Range | To configure Input/Output 1 | | To configure Output 2 | To configure Output AA |
|---|--|--|--|---|--|
| Thermocouple B = Type B J = Type J K = Type K L = Type L N = Type N R = Type R S = Type S T = Type T C = Custom RTD P = Pt100 PRT Linear M = 0-50mV 2 = 0-20mA 4 = 4-20mA | C = °C Full Range F = °F Full Range 0 = 0-100.0°C 1 = 0-200.0°C 2 = 0-400.0°C 3 = 0-600°C 4 = 0-800°C 5 = 0-1000°C 6 = 0-1200°C 7 = 0-1400°C 8 = 0-1600°C 9 = 0-1800°C G = 32-212.0°F H = 32-392.0°F J = 32-752.0°F K = 32-1112°F L = 32-1472°F M = 32-1832°F N = 32-2192°F P = 32-2552°F R = 32-2912°F T = 32-3272°F | Control OP (relay/logic/DC) Table A | | Control OP (relay/logic/DC) Table A | Control OP (relay only) Table A |
| | | Retrans OP (DC only) Table B | | Retrans OP (DC only) Table B | |
| | | Alarm OP (relay/logic) Table C | | Alarm OP (relay/logic) Table C | Alarm OP (relay only) Table C |
| | | Logic Input Table D | | | |
| | | Table A | Table B | Table C | Table D |
| | | Control H = Heat PID C = Cool PID (H & C include 4-20mA) J = Heat On/off (logic & relay); PID (0-20mA) K = Cool On/off (logic & relay); PID (0-20mA) | Retrans 4-20mA D = WSP E = PV F = OP Retrans 0-20mA N = WSP Y = PV Z = OP | Alarm (energised in alarm) 0 = High 1 = Low 2 = Deviation high 3 = Deviation low 4 = Deviation band (de-energised in alarm) 5 = High 6 = Low 7 = Dev high 8 = Dev low 9 = Dev band | Logic Input M = Manual L = Key lock P = Setpoint 2 U = Remote SP comms W = Alarm ack R = Run/hold T = Reset V = Recipe 2/1 select |
| X In any column = not fitted | | | | | |

SET 2

I W X X T

| To configure Input CT Scaling | To configure Digital Input | To configure Lower Display |
|---|---|--|
| 1 = 10 Amps 2 = 25 Amps 5 = 50 Amps 6 = 100 Amps X in any column = Not fitted | W = Alarm Ack M = Manual R = Run/hold L = Keylock P = Setpoint 2 T = Reset U = Remote setpoint comms V = Recipe 2/1 select | T = Setpoint (standard) P = Output power % R = Time to run E = Elapsed time 1 = First Alarm setpoint A = Amps D = Dwell/Ramp N = None |

To Re-Enter Quick Code mode

If you need to re-enter the 'Quick Configuration' mode, power down the controller, hold down the  button, then power up the controller. Keep the button pressed until 'E [] E' appears. You must then enter a passcode using the  or  buttons. In a new controller the passcode defaults to 4. If an incorrect passcode is entered you must repeat the whole procedure. You can then re-configure the controller through the Quick Codes.

Note:- If the quick codes re-appear with decimal points between each character this means THE QUICK CODES MAY NO LONGER BE VALID. This is because a parameter (not necessarily a Quick Code parameter) which is available in the controller in a deeper level of access* has been altered. You can, however, re-adjust the Quick Codes again at this point (or proceed to the ^{YES}E_{XT} state) to re-configure the controller.

* The procedure for a full configuration is described in the 3116/3216 Engineering Handbook Part No. HA027986 which may be downloaded from www.eurotherm.co.uk.

5.3 Pre-Configured Controller or Subsequent Starts

The controller will briefly display the quick codes during start up but will then proceed to operator level 1.

Note:- If the Quick Codes do not appear during start up this means that the controller has been re-configured in a deeper level of access, as stated above, and the Quick Codes may no longer be valid. The controller will power up in mode it was in prior to shutdown and you will see the display shown below. It is called the HOME display.

In this view
the controller
is in AUTO
mode

The OP1 beacon will be
on if output 1 is
configured for heat
and calling for power

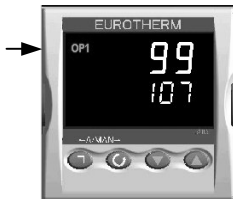

Measured Temperature
(or Process Value 'PV')

Required Temperature
(or Setpoint 'SP')

5.4 Operator Interface

Beacons:-

- OP1 lit when output 1 is ON (normally heating)
- OP2 lit when output 2 is ON (normally cooling)
- OP4 lit when AA relay is ON (normally alarm)
- SPX Alternative setpoint in use (SP2)
- ALM Alarm active (Red)
- REM Remote setpoint or communications active
- RUN Timer running
- RUN (flashing) Timer in hold
- MAN Manual

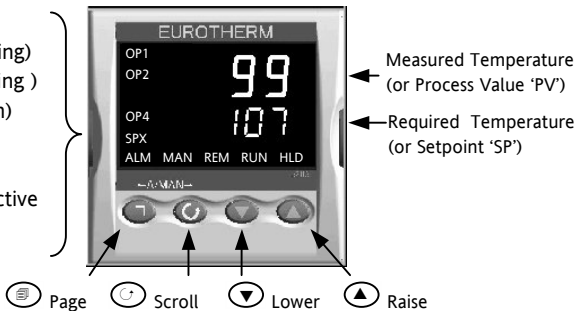

Operator Buttons:-



From any display - press to return to the HOME display



Press to select a new parameter. If held down it will continuously scroll through parameters.



Press to decrease an analogue value or to change the state of a digital (enumerated) value



Press to increase an analogue value or to change the state of a digital (enumerated) value

5.4.1 To Set The Required Temperature.

From the HOME display:-



Press  to raise the setpoint

Press  to lower the setpoint

The new setpoint is entered when the button is released and is indicated by a brief flash of the display.

5.4.2 Alarm Indication

If an alarm occurs the red ALM beacon will flash, a scrolling message will give the source of the alarm and the alarm (relay) output will operate.

Press  and  (ACK) together to acknowledge



If the alarm is still present the ALM beacon lights continuously.

The action which takes place depends on the type of alarm configured:-

| | |
|-----------------|--|
| Non latching | A non latching alarm will reset itself when the alarm condition is removed |
| Auto Latching | An auto latching alarm requires acknowledgement before it is reset. The acknowledgement can occur BEFORE the condition causing the alarm is removed. |
| Manual Latching | The alarm continues to be active until both the alarm condition is removed AND the alarm is acknowledged. The acknowledgement can only occur AFTER the condition causing the alarm is removed. |

5.4.3 Auto/Manual/Off Mode



Auto mode is the normal closed loop operation where the output is adjusted automatically by the controller in response to a change in the input signal.







Manual mode means that the controller output power can be adjusted directly by the user. The input sensor is still connected and reading the PV but the control loop is open. The current level of the power output is adopted at the point of switch over from Auto to Manual. This is referred to as 'Bumpless Transfer'. The power output can be increased or decreased using the  or  buttons. Similarly, when Manual to Auto is selected the current manual output power is taken and the controller will then take over control. If the controller is powered down it will resume the same mode when powered up again.

Off mode can be selected or when using a timer configured to turn the power output off at the end of a timed period.

 Manual operation must be used with care and the power level set must be chosen such that no damage can occur to the process. The use of a separate 'over-temperature' controller is recommended.

5.4.4 To Select Manual Operation and Adjust the Output Power

Press and hold  and  (Mode) together for more than 1 second. This can only be accessed from the HOME display.

1. 'Auto' is shown in the upper display. The lower display will scroll the longer alternate description of this parameter, ie 'LOOP MODE - AUTO MANUAL OFF'
2. Press  to select 'mAn'. This is shown in the upper display and the **MAN** beacon is lit.
3. The controller will return to the HOME display. The upper display shows PV. The lower display shows demand power. At the point of changeover the manual demand power is the same as it was when in Auto (bumpless transfer auto to manual).
4. Press  or  to lower or raise the power. The output power is continuously updated when these buttons are pressed
5. The loop can also be turned off (zero power output demand) by selecting 'OFF' in the upper display. Loop break is also turned off. The controller will return to the HOME display. The upper display shows the PV. The lower display shows OFF. The **MAN** beacon is lit in this mode.
6. To Return to Automatic operation, press  and  together. Then press  to select 'Auto'. At the point of changeover to automatic operation the power demand takes the current value and gradually changes to that required by the controller bumpless transfer manual to auto)







5.4.5 Other Commonly Used Operator Parameters Available in Level 1

Operator level 1 is designed for day to day operation of the controller and parameters are not protected by a security code.

Press  to scroll through a list of commonly used parameters.



A list of other operating parameters is available each time this button is pressed. The parameter mnemonic and its scrolling description are shown in the lower display. The value of the parameter is shown in the upper display. The actual parameters shown depend upon the functions configured and are:-

| Parameter Mnemonic and Scrolling Display | Description | Alterability |
|--|--|---|
| WRK.OP WORKING OUTPUT | The current output | Shown when the controller is in AUTO or OFF mode and is read only |
| WKG.SP WORKING SETPOINT | The setpoint which the controller is currently using | Only shown when the controller is in MAN or OFF mode and is read only |
| SP1 (or 2) SETPOINT 1 (or 2) | To adjust setpoint 1 (or 2) | Press  or  to adjust |
| T.REMN TIME REMAINING | Time to end of set timer period | Read only 0:00 to 99.59 hh:mm or mm:ss |
| DWELL SET TIME DURATION | Set dwell time | Only shown if timer (not programmer) configured. Press  or  to adjust |
| AX.YYY ALARM X SETPOINT X= alarm number YYY= alarm type | Alarm 1, 2, 3 or 4 setpoint (if the alarm is configured) | Read only |
| LD.AMP LOAD CURRENT | Load current | Read only and only shown if CT is configured |





6. Operator Level 2

Level 2 provides access to additional parameters and access to these is protected by a security code.

6.1 To Enter Level 2

1. From any display press and hold .
2. After a few seconds the display will show 'LEU 1 GOTO'.
3. Release .



(If no button is pressed for about 45 seconds the display returns to the HOME display)

4. Press  or  to choose LEU 2 (Level 2)
5. Press  or  to enter the correct code
6. By default this is set to '2'

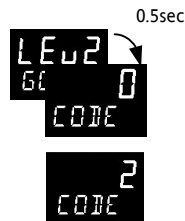
If an incorrect code is entered the display reverts to Level 1.





6.2 To Return to Level 1



1. Press and hold .
2. Press  to select LEU 1

It is not necessary to enter a code when going from a higher level to a lower level.
When Level 1 is selected the display reverts to the HOME display

6.3 Level 2 Parameters

Press  to scroll through the list of parameters. The mnemonic of the parameter is shown in the lower display, followed once by a scrolling help message showing a longer description of the parameter.

The value of the parameter is shown in the upper display. Press  or  to adjust this value. If no key is pressed for about 30 seconds the display returns to 'HOME'

Backscroll is achieved when you are in the list by pressing  while holding down .

| Mnemonic | Scrolling Display and description | Range |
|----------|---|--|
| WKG.SP | WORKING SETPOINT is the current target setpoint and appears when the controller is in Manual. It may be derived from SP1 or SP2, or, if the controller is ramping (see SP.RAT), it is the current ramp value. | SP.HI to SP.LO |
| WRK.OP | WORKING OUTPUT is the output from the controller expressed as a percentage of full output. It appears when the controller is in Auto. Range -100% (Max cooling) to +100% (max heating). For a time proportioning output, 50% = relay or logic output on or off for equal lengths of time. For an On/Off output 0 to <1% = output off, >1 to 100% = output on | 0 to 100% heat only -100 to 100% heat + cool |
| T.STAT | TIMER STATUS is only shown if a timer is configured. Allows the timer to be put into Run, Hold or Reset mode. | <i>rES</i> Reset <i>run</i> Running <i>hoLd</i> Hold <i>End</i> Timed out |

| Mnemonic | Scrolling Display and description | | Range |
|---|---|------------------------|--------------------------------------|
| UNITS | DISPLAY UNITS | $^{\circ}C$ | Degrees C |
| | | $^{\circ}F$ | Degrees F |
| | | $^{\circ}K$ | Degrees K |
| | | <i>nonE</i> | None |
| | | <i>PERc</i> | Percentage |
| SP.HI | SETPOINT HIGH allows a high limit to be applied to SP1 and SP2 | | As quickcode SET1 |
| SP.LO | SETPOINT LOW allows a low limit to be applied to SP1 and SP2 | | |
| SP1 | SETPOINT 1 allows the value of setpoint 1 to be adjusted | | SP.HI to SP.LO |
| SP2 | SETPOINT 2 allows the value of setpoint 2 to be adjusted | | SP.HI to SP.LO |
| SP.RAT | SETPOINT RATE LIMIT sets the rate of change of setpoint. Limits the rate of heating or cooling. | | OFF to 3000 display units per minute |
| ----- This section applies to the Timer only – see also section 6.4 | | | |
| TM.CFG | TIMER CONFIGURATION configures the timer type - Dwell, Delay, Soft Start or none (only when in Reset) Note Programmer option is only shown if the programmer option has been ordered. | <i>nonE</i> | None |
| | | <i>dwE11</i> | Dwell |
| | | <i>dELY</i> | Delayed switch on |
| | | <i>SFS_t</i> | Soft start |
| | | <i>PrOG</i> | Programmer |
| TM.RES | TIMER RESOLUTION selects hours or minutes (only when in Reset) | <i>Hour</i> | Hours |
| | | <i>mi n</i> | Minutes |

| Mnemonic | Scrolling Display and description | Range | |
|----------|---|-------------------------------|--------------------------|
| THRES | TIMER START THRESHOLD The timer will not run until the PV becomes in range of the value set by this parameter. This value can be changed when the timer is running. | OFF or 1 to 3000 | |
| END.T | TIMER END TYPE The action of the timer when it has timed out can be selected from Dwell (control continues at the setpoint), Off (control outputs turn off), SP2 (control at setpoint 2). Can be changed while the timer is running. | OFF | Control OP goes to zero |
| | | dwE11 | Control continues at SP1 |
| | | SP2 | Go to SP2 |
| SS.PWR | SOFT START POWER LIMIT Sets the power limit during start up | -100 to 100% | |
| SS.SP | SOFT START SETPOINT sets the threshold below which the power is limited | Between SP.HI and SP.LO | |
| DWELL | SET TIME DURATION - can be adjusted while the timer is running. This parameter only appears for a Dwell type timer. | 0:00 to 99.59 hh:mm: or mm:ss | |
| T.REMN | TIME REMAINING Time remaining to reach the set time | 0:00 to 99.59 hh:mm: or mm:ss | |

The following parameters are available when the timer is configured as a programmer – see also section 6.9

| | | | |
|--------|---|----|------------------|
| SERVO | SERVO MODE. The program will start from the current setpoint value or from the current value of the process variable | SP | Setpoint |
| | | PV | Process variable |
| TSP.1 | TARGET SETPOINT 1. To set the target value for the first setpoint | | |
| RMP.1 | RAMP RATE 1. To set the first ramp rate | | |
| DWEL.1 | DWELL 1. To set the period of the first dwell | | |

Mnemonic**Scrolling Display and description****Range**

The above three parameters are repeated for the next three program segments, i.e. TSP.2 (3 & 4), RMP.2 (3 & 4), DWEL.2 (3 & 4)

This section applies to Alarms only If an alarm is not configured the parameters do not appear

A1.--- - to **ALARM 1 (2, 3 or 4) SETPOINT** sets the threshold value at which an alarm is detected. Up to four alarms are available and are only shown if configured. SP.HI to SP.LO

--- = the mnemonic for the alarm type which may be:-

| | | | | | |
|-----|------------|-----|-----------|----|-----------|
| L 0 | Full Scale | BNB | Deviation | HI | Deviation |
| | Low | | Band | | High |
| H 1 | Full Scale | LD | Deviation | | |
| | High | | Low | | |

This section applies to control parameters

| | | | |
|--------|---|-------------|---------------|
| A.TUNE | AUTOTUNE automatically sets the control parameters to match the process characteristics. | OFF | Disable |
| | | On | Enable |
| PB | PROPORTIONAL BAND sets an output which is proportional to the size of the error signal. Units may be % or display units. | 1 to 9999 | display units |
| TI | INTEGRAL TIME removes steady state control offsets by ramping the output up or down in proportion to the amplitude and duration of the error signal. | OFF to 9999 | seconds |

| Mnemonic | Scrolling Display and description | Range |
|----------|--|--|
| TD | DERIVATIVE TIME determines how strongly the controller will react to the rate of change in the process value. It is used to prevent overshoot and undershoot and to restore the PV rapidly if there is a sudden change in demand. | <i>OFF</i> to 9999 seconds |
| MR | MANUAL RESET applies to a PD only controller i.e. the integral term is turned off. Set this to a value of power output (from +100% heat, to -100% cool which removes any steady state error between SP and PV. | -100 to 100% |
| R2G | RELATIVE COOL GAIN adjusts the cooling proportional band relative to the heating proportional band. Particularly necessary if the rate of heating and rate of cooling are very different. (Heat/Cool only) | 0.1 to 10.0 |
| HYST.H | HEATING HYSTERESIS sets the difference in PV units between output 1 turning off and turning on. Only shown if channel 1 control action is On/Off. | 0.1 to 200.0 display units |
| HYST.C | COOLING HYSTERESIS sets the difference in PV units between output 2 turning off and turning on. Only shown if channel 2 control action is On/Off. | 0.1 to 200.0 display units |
| D.BAND | CHANNEL 2 DEADBAND adjusts a zone between heating and cooling outputs when neither output is on. Off = no deadband. 100 = heating and cooling off. On/Off controllers only. | <i>OFF</i> or 0.1 to 100.0% of the cooling proportional band |

| Mnemonic | Scrolling Display and description | Range |
|--|---|-------------------|
| OP.HI | OUTPUT HIGH limits the maximum heating power applied to the process or a minimum cooling output. | +100% to OP.LO |
| 1. (2 or 4) PLS. | OUTPUT 1 (2 or AA) MINIMUM PULSE TIME to set the minimum on/off time for the output. Relay outputs are adjustable from 0.1 to 150 seconds. Logic outputs set to Auto = 55ms. | Auto to 150.0 |
| ----- | | |
| This section applies to current transformer input only. If the CT option is not configured the parameters do not appear | | |
| LD.AMP | LOAD CURRENT is the measured load current when the power demand is on | CT Range |
| LK.AMP | LEAK CURRENT is the measured leakage current when the power demand is off. | CT Range |
| LD.ALM | LOAD CURRENT THRESHOLD sets a low alarm trip point for the load current as measured by the CT. This detects partial load failure. | CT Range |
| LK.ALM | LEAK CURRENT THRESHOLD sets a high alarm trip point for the leakage current measured by the CT. | CT Range |
| HC.ALM | OVERCURRENT THRESHOLD sets a high alarm trip point to show over current as measured by the CT | CT Range |
| ----- | | |
| ADDR | ADDRESS - communications address of the controller. 1 to 254 | 1 to 254 |
| ----- | | |
| HOME | HOME DISPLAY Defines the parameter which appears in the lower | Std Standard |

| Mnemonic | Scrolling Display and description | Range |
|----------|--|---|
| | | <i>OP</i> Output power |
| | | <i>t_r</i> Time remaining |
| | | <i>ELAP</i> Time elapsed |
| | | <i>AL</i> First alarm setpoint |
| | | <i>CL</i> Load current |
| | | <i>CL_r</i> Clear (blank) |
| | | <i>t_{mr}</i> Combined setpoint and time display |
| ID | CUSTOMER ID is a number from 0 to 9999 entered as a customised identification number for the controller | 0 to 9999 |
| REC.NO | CURRENT RECIPE NUMBER the most frequently used parameters can be stored in up to 5 recipes. This parameter selects the recipe to use. | <i>nonE</i> or <i>1 to 5</i> or <i>FA, L</i> if no recipe set stored |
| STORE | RECIPE TO SAVE the most frequently used parameter s can be stored in up to 5 recipes. This parameter allows you to store the current values in recipe numbers 1, 2, 3, 4, or 5. None does not store values. | <i>nonE</i> or <i>1 to 5</i> <i>donE</i> when stored |

☺ Press  at any time to return immediately to the HOME screen at the top of the list.

☺ Hold  down to continuously scroll through the above list

6.4 Timer

A timer can be configured to operate in four different modes. These can be selected in Level 2 using the 'TM.CFG' parameter as:-

- Dwell Timer
- Delayed switch on timer
- Soft start timer
- Programmer if this has been ordered

There are four operating states:

1. **Run.** This starts the timer
2. **Hold.** This stops the timer at the elapsed time. It will start again from the elapsed time when Run is selected again.
3. **Reset.** This sets the timer back to zero. It can be run again from this state.
4. **End** cannot be set - it occurs automatically when the timer has counted down to zero

Run, Hold and Reset may be set through the front panel as described in section 6.8 or by the following methods:-

- Edge trigger a suitably configured digital input
- Power cycle the controller
- Digital communications command
- Selecting '**T.STAT**' from the parameter list

Switching from Hold to Run through the front panel buttons is not allowable if the Hold status is forced by a logic input or through Digital Communications.

6.4.1 Timer Beacon

Timer operation is indicated by a beacon labelled RUN:

| Timer Status | RUN beacon | Timer Status | RUN beacon |
|--------------|------------|--------------|------------|
| Reset | Off | Hold | Flashing |
| Run | On | End | Off |

6.4.2 Logic outputs

The timer may be configured to operate an output when it is running or during the end state

Note:-

- **Power up** - the 'run' state is selected if a Soft Start or Delay timer is configured or the 'Reset' state is selected if a Dwell timer is configured.
- **Auto/Manual** is only available when the timer is in Reset
- **Ramp Rate** – it is recommended that ramp rate is used only with a Dwell type timer

Quick access to the timer operating parameters is available in Level 2 by pressing . Repeat pressing of this button shows Timer Status, Dwell, Working Output, SP1, SP2, etc

6.4.3 Power Cycling

If the power is turned off when the timer is running it will come back on as follows:-

For a Dwell type timer it will come back on in Reset

For a Delayed Switch on timer or a Soft Start timer, the controller will come back on in the Run condition and start again from the beginning.

6.5 Dwell Timer

A dwell timer ('**TI.CFG**' = '**DWELL**') is used to control a process at a fixed temperature for a defined period. The action which occurs at the end of the timed period depends on the configuration of the '**END.T**' parameter.

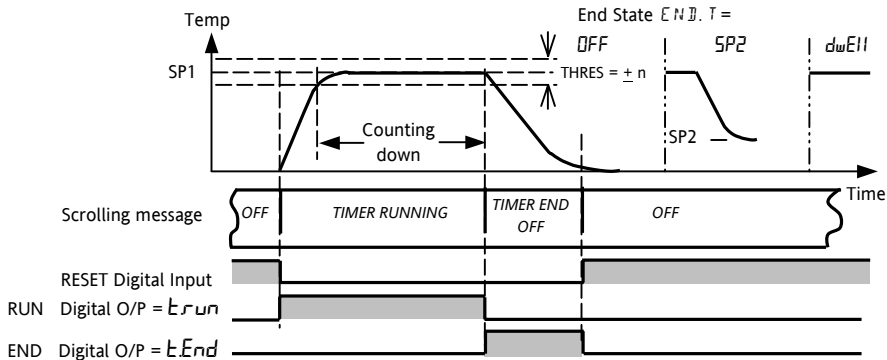

Notes:

1. If '**THRES**' = 2° (for example) timer will show **TIMER RUNNING** with the **RUN** beacon on but will not start counting down until the temperature is, first, within 2° of **SP**. Then the threshold is ignored.
2. The dwell period can be reduced or increased when the timer is running. If it is reduced to meet the Time Elapsed the timer will change to the End state.
3. A-M can only be selected when in reset
4. If the timer is re-configured to a different type or the End Type is re-configured (a dwell, for example), it may be necessary to reselect Auto mode

6.6 Delayed Switch On Timer

The timer is used to switch on the output power after a set time.

When the timer status = run, the control output is off

When the timer status = reset, the control output is controlling at SP1

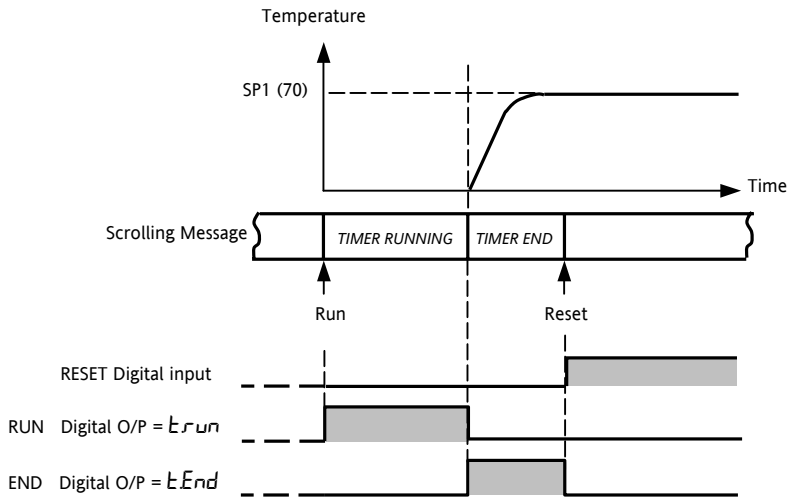

6.7 Soft Start Timer

The timer is used to start a process at reduced power and/or reduced setpoint. Timing starts at power up or when 'Run' is selected.





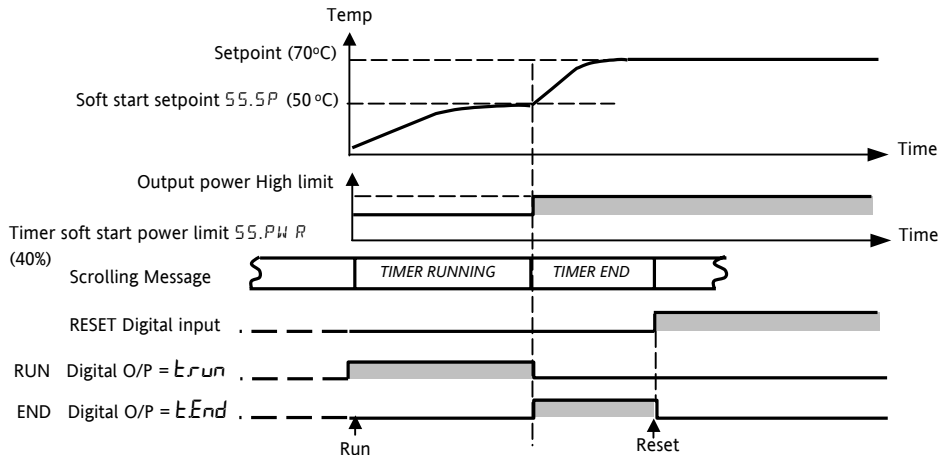





When the Timer Status = Run, the controller power is limited by the soft start power limit parameter. The Soft Start setpoint is a threshold which, when exceeded, sets the timer to end. If the temperature is already above this threshold when the timer is set to run, the timer will time out immediately.

When the timer status = reset, the controller is controlling at SP1



6.8 To Operate the Timer

If the timer is configured it can be operated in Level 1 or Level 2 as follows:-

| Operation | Action | Indication |
|--|--|---|
| To Run the timer | Press and quickly release  +  | Beacon -- RUN = On Scrolling display - TIMER RUNNING |
| To Hold the timer | Press and quickly release  +  | Beacon -- RUN = Flashing Scrolling display - TIMER HOLD |
| To Reset the timer | Press and hold  +  for more than 1 second | Beacon -- RUN = Off If the timer is a Dwell Type and configured to turn power off at the end of the timing period OFF will be displayed |
| | Timer has timed out | Beacon -- RUN = Off SPX = On if End Type = SP2 Scrolling display - TIMER END |
| To Reset the timer after it has timed out | Press and hold  +  for more than 1 second | Beacon -- RUN = Off SPX = On if End Type = SP2 If the timer is a Dwell Type and configured to turn power off at the end of the timing period OFF will be displayed. |
| To Cancel the 'end' output (if configured) | Press  +  | If a logic (relay) output is configured to operate when the timer has timed out, it can be cancelled by pressing these two buttons (Ack) |
| Repeat the above to Run the timer again (Note: it is not essential to reset it after the End state is reached) | | |

Note 1: When the timer has been reset, press  +  for more than 1second to select Auto/Manual mode.

Note 2: The time can be extended by changing the T.REMN parameter. If the timer has timed out it will automatically run again.

Any output, not used for control, can be configured to operate while the timer is running and/or when it has timed out.

6.9 Programmer

Model type CP is a controller which also contains a four segment setpoint programmer where each segment consists of a controlled rate ramp to a target setpoint followed by a dwell at that setpoint. These values can be set by the user. The program profile is shown in the diagram below.

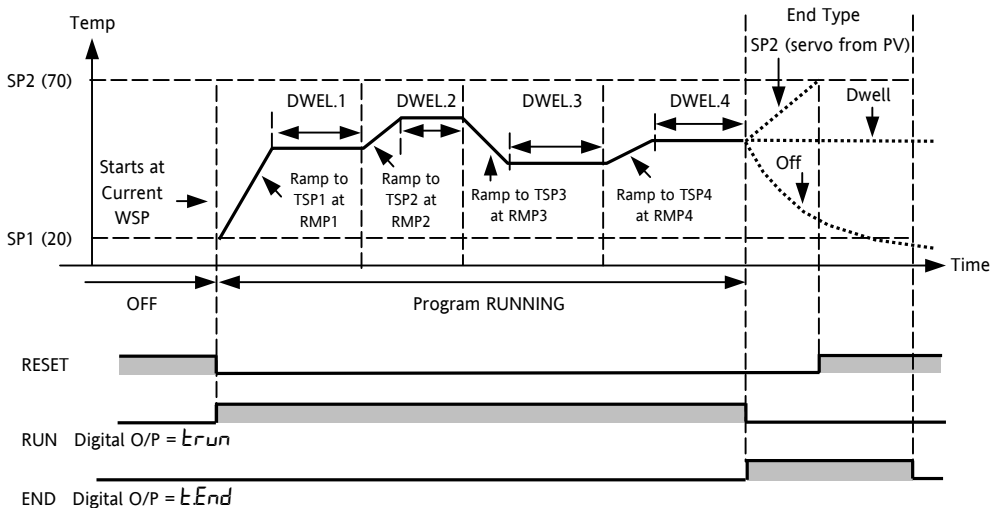

Notes:-

Where steps are required, the ramp rate in the ramp/dwell pair should be set to 'OFF'.

1. Where ramp/dwell pairs are not required, the ramp rate should be set to 'OFF' and the TSP the same as the preceding segment
2. TIMER END - when end type is SP2, Timer END does not occur until the ramp is complete or SP2 is achieved. It is more usual to use a DWELL end type (the default setting)

6.9.1 Power Cycling (Programmer)

If the power is turned off while the programmer is running the program will reset when the power to the controller is turned back on





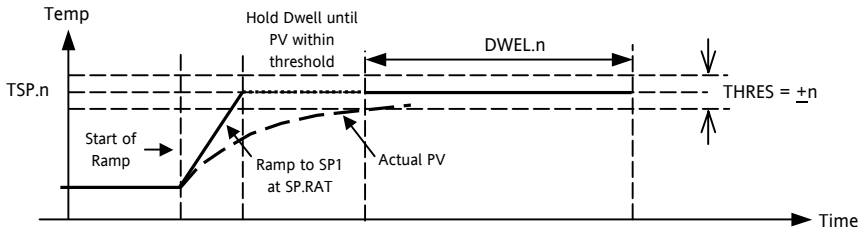





6.9.2 Threshold

A single threshold value is available to provide a holdback on the entry to the dwell part of the ramp/dwell pair. It holds back the dwell until the PV has reached the band defined by +/- threshold around the PV as shown below:-



6.9.3 To Operate the Programmer













Operation of the programmer is the same as the timer.

















| Operation | Action | Indication |
|---|---|---|
| To Run a program | Press and quickly release  +  | Beacon -- RUN = On Scrolling display - TIMER RUNNING |
| To Hold a program | Press and quickly release  +  | Beacon -- RUN = Flashing Scrolling display - TIMER HOLD |
| To Reset a program | Press and hold  +  for more than 1 second | Beacon -- RUN = Off If End Type = Off then OFF will be displayed at the end of the program |
| | Program ended | Beacon -- RUN = Off SPX = On if End Type = SP2 Scrolling display - TIMER END |
| To Reset a program after it has timed out | Press and hold  +  for more than 1 second | Beacon -- RUN = Off SPX = On if End Type = SP2 If the programmer is configured to turn power off at the end of the timing period OFF will be displayed. |
| To Cancel the ' end ' (relay) output (if configured) | Press  +  | If a logic (relay) output is configured to operate when the programmer has timed out, it can be cancelled by pressing these two buttons (Ack) |
| Repeat the above to Run the programmer again (Note: it is not essential to reset it after the End state is reached) | | |

Programs can also be operated from the '**T.STAT**' parameter found in the level 2 parameter list.

6.9.4 To Configure the Programmer

Select Access Level 2 – see section 6.

| Operation | Action | Indication | Notes |
|--|--|--|---|
| Configure the Timer as a Programmer | <ol style="list-style-type: none">1. Press  as many times as necessary to 'TM.CFG'2. Press  or  to 'Prog' |  | |
| Set the Resolution | <ol style="list-style-type: none">3. Press  as many times as necessary to 'TM.RES' <p>Press  or  to 'Hour' or 'min'</p> |  | In this example the ramp rate and dwell period are set in hours |
| Set the Threshold | <ol style="list-style-type: none">4. Press  as many times as necessary to 'THRES'5. Press  or  to adjust |  | In this example the dwell periods will not start until the PV is within 5 units of the setpoint |

| | | | |
|--|--|--|--|
| <p>Set the Servo Mode</p> | <p>6. Press  as many times as necessary to 'SERVO'</p> <p>7. Press  or  to 'PU' or 'SP.'</p> |  | <p>In this example the program will start from the current value of the process variable</p> |
| <p>Set the first Target Setpoint</p> | <p>8. Press  as many times as necessary to 'TSP.1'</p> <p>9. Press  or  to adjust</p> |  | <p>In this example the setpoint will ramp from the current value of the PV to the first target - 100</p> |
| <p>Set the first Ramp Rate</p> | <p>10. Press  as many times as necessary to 'RMP.1'</p> <p>11. Press  or  to adjust</p> |  | <p>In this example the setpoint will ramp to 100 at 8.0 units per hour</p> |
| <p>Set the first Dwell</p> | <p>12. Press  as many times as necessary to 'DWEL.1'</p> <p>13. Press  or  to adjust</p> |  | <p>In this example the setpoint will dwell at 100 for 2 hours 11 minutes</p> |
| <p>Repeat the above three steps for all segments</p> | | | |

 This indicator meets the European directives on safety and EMC

INTERNATIONAL SALES AND SERVICE

AUSTRALIA Sydney
Eurotherm Pty. Ltd.
Telephone (+61 2) 9838 0099
Fax (+61 2) 98389288

AUSTRIA Vienna
Eurotherm GmbH
Telephone (+43 1) 7987601
Fax (+43 1) 7987605

BELGIUM Moha &
LUXEMBURG Huy
Eurotherm S.A./N.V.
Telephone (+32) 85 274080
Fax (+32) 85 274081

BRAZIL Campinas-SP
Eurotherm Ltda.
Telephone (+55 19) 3237 3413
Fax (+55 19) 3234 7050

DENMARK Copenhagen
Eurotherm Danmark A/S
Telephone (+45 70) 234670
Fax (+45 70) 234660

FINLAND ABO
Eurotherm Finland
Telephone (+358) 22506030
Fax (+358) 22503201

FRANCE Lyon
Eurotherm Automation SA
Telephone (+33 478) 664500
Fax (+33 478) 352490

GERMANY Limburg
Eurotherm Deutschland GmbH
Telephone (+49 6431) 2980
Fax (+49 6431) 298119
Also regional offices

HONG KONG Aberdeen
Eurotherm Limited
Telephone (+852) 28733826
Fax (+852) 28700148

INDIA Chennai
Eurotherm India Limited
Telephone (+9144) 4961129
Fax (+9144) 4961831

IRELAND Dublin
Eurotherm Ireland Limited
Telephone (+353 01) 4691800
Fax (+353 01) 4691300

ITALY Como
Eurotherm S.r.l
Telephone (+39 031) 975111
Fax (+39 031) 977512

KOREA Seoul
Eurotherm Korea Limited
Telephone (+82 31) 2868507
Fax (+82 31) 2878508

NETHERLANDS Alphen a/d Ryn
Eurotherm B.V.
Telephone (+31 172) 411752
Fax (+31 172) 417260

NORWAY Oslo
Eurotherm A/S
Telephone (+47 67) 592170
Fax (+47 67) 118301

SPAIN Madrid
Eurotherm España SA
Telephone (+34 91) 6616001
Fax (+34 91) 6619093

SWEDEN Malmo
Eurotherm AB
Telephone (+46 40) 384500
Fax (+46 40) 384545

SWITZERLAND Freienbach
Eurotherm Produkte (Schweiz) AG
Telephone (+41 55) 4154400
Fax (+41 55) 4154415

UNITED KINGDOM Worthing
Eurotherm Limited
CONTROLS &
DATA MANAGEMENT
Telephone (+44 1903) 695888
Fax (+44 1903) 695666
PROCESS AUTOMATION
Telephone (+44 1903) 205277
Fax (+44 1903) 236465

U.S.A Leesburg
Eurotherm Inc.
Telephone (+1 703) 443 0000
Fax (+1 703) 669 1300
Web www.eurotherm.com

ED 36

<http://www.eurotherm.co.uk>

© Copyright Eurotherm Limited 2004

All rights strictly reserved. No part of this document may be stored in a retrieval system, or any form or by any means without prior written permission from Eurotherm Limited. Every effort has been taken to ensure the accuracy of this specification. However in order to maintain our technological lead we are continuously improving our products which could, without notice, result in amendments or omissions to this specification.



HA027985ENG